

ELECTRO-PROPORTIONAL VALVES—DIRECTIONAL CONTROL

SP08-47D Spool, 4-Way, 3-Position, "Motor Spool"

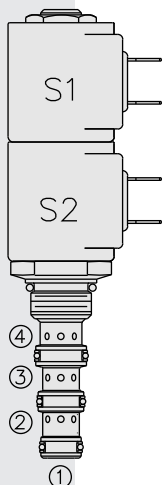

DESCRIPTION

A proportional solenoid-operated, four-way, three-position, spool-type, motor spool, screw-in hydraulic cartridge valve.

OPERATION

When de-energized, the **SP08-47D** blocks flow to 3 while allowing flow from 2 to 1, and from 4 to 1. When coil S1 is energized flow is allowed from 3 to 4 and from 2 to 1. When coil S2 is energized flow is allowed from 3 to 2 and from 4 to 1.

Initial meter-in flow begins at a nominal 0.4 amp on a 12 VDC system. Full flow of 3 gpm occurs at 1.0 to 1.1 amp on a 12 VDC system. Each coil has its own metering characteristics, which are quite similar (see performance chart).

While port 1 may be fully pressurized, it is not intended for use as the valve's inlet.

In circuits where work port flows are unequal due to cylinder ratios, the higher return flow should be directed to port 2.

FEATURES

- Continuous-duty rated solenoids.
- Optional coil voltages and terminations.
- Efficient wet-armature construction.
- Hardened precision spool and cage for long life.
- Cartridges are voltage interchangeable.
- Optional waterproof E-Coils rated up to IP69K.
- Designed for good linearity and hysteresis.
- Optional manual override.
- Industry-common cavity.

RATINGS

Operating Pressure: 240 bar (3500 psi)

Flow: 11.4 lpm (3 gpm) max. (see performance chart); Flow rate is based on 50% duty cycle and coil temperature of 20°C (140°F). Consult factory if higher duty cycle and coil temperatures are anticipated.

Internal Leakage: 328 cc/minute (20 cu. in./minute) max. per side at 207 bar (3000 psi)

Hysteresis: Less than 7%

Temperature: -40 to 120°C with standard Buna seals

Coil Duty Rating: Standard Coils and E-Coils: Continuous up to 115% of nominal voltage

Filtration: See page 9.010.1

Fluids: Mineral-based or synthetics with lubricating properties at viscosities of 7.4 to 420 cSt (50 to 2000 sus); See Temperature and Oil Viscosity, page 9.060.1

Installation Recommendation: When possible, the valve should be mounted below the reservoir oil level. This will maintain oil in the armature preventing trapped air instability. If this is not feasible, mount the valve horizontally for best results. See page 9.020.1

Cavity: VC08-4; See page 9.108.1; **Cavity Tool:** CT08-4XX; See page 8.600.1

Seal Kit: SK08-4X-MMM; See page 8.650.1

Coil Nut: Part No. 7004400; **Manual Override Coil Nut:** Part No. 4528180;

Coil Spacer: Std D-Coil Spacer Part No. 7012940; E-Coil Spacer Part No. 4534720; If cartridge is ordered "Less Coil," D-Coil spacer will be provided unless an E is specified in the Coil Termination To Order section.

SYMBOLS

USASI:

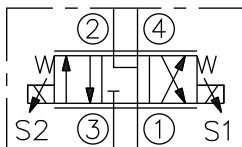

ISO:

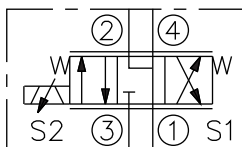

PERFORMANCE (Cartridge Only)

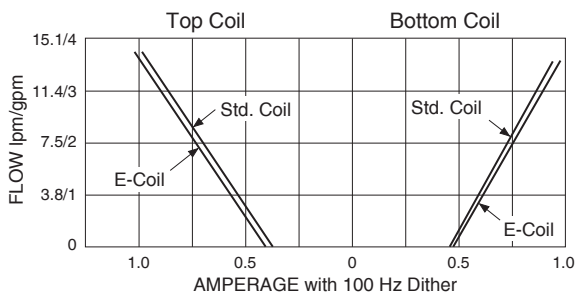
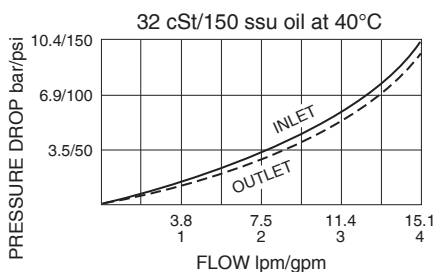

Recommended Electronic Controllers:

See page 2.001.1 or our Electronics catalog.

Performance information continued on following page.

PERFORMANCE (cont'd.)

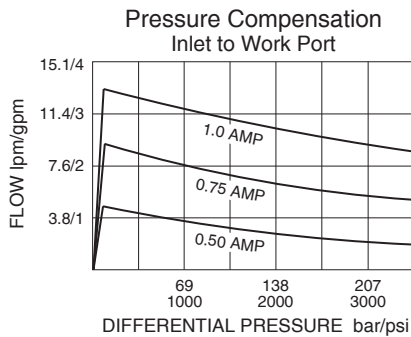

DIMENSIONS

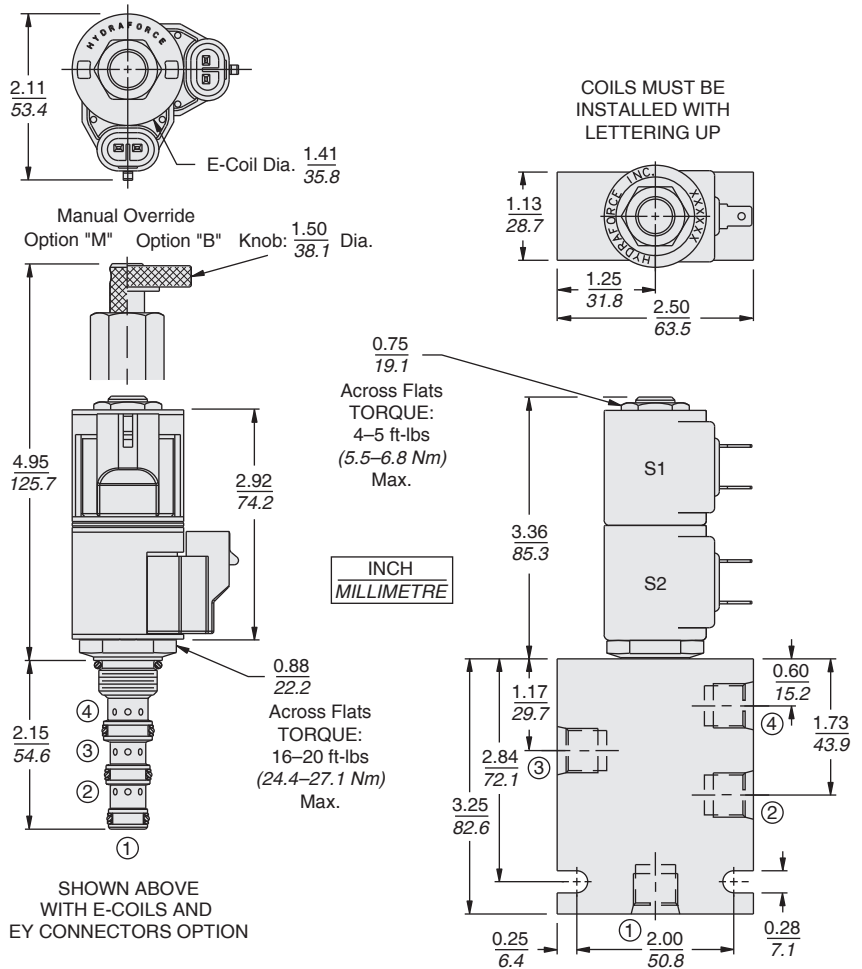

MATERIALS

Cartridge: Weight: 0.13 kg. (0.28 lbs.) Steel with hardened work surfaces. Zinc-plated exposed surfaces. Buna N O-rings and back-ups std.

Standard Ported Body: Weight: 0.18 kg. (0.40 lbs.) Anodized high-strength 6061 T6 aluminum alloy, rated to 207 bar (3000 psi). Ductile iron bodies available; dimensions may differ. See page 8.008.1.

Standard Coil: 2 Required. Weight each: 0.11 kg. (0.25 lbs.); Unitized thermoplastic encapsulated, Class H high temperature magnet wire. See page 3.200.1.

E-Coil: 2 Required. Weight each: 0.14 kg. (0.3 lbs.); Perfect wound, fully encapsulated with rugged external metal shell; Rated up to IP69K with integral connectors. See page 3.400.1

TO ORDER

SP08-47D

| | | | |
|--|--------------|-----------------------------------|--------------------|
| Option | None (Blank) | Voltage | Std. D-Coil |
| Manual Override | M | 00 | Less Coil** |
| Manual Override | B | 12 | 12 VDC |
| | | 24 | 24 VDC |
| For Manual Override options see page 1.001.1 | | **Includes D-Coil Nut and Spacer. | |
| Porting | 0 | E-Coil | 12 12 VDC |
| Cartridge Only | 6T | 24 | 24 VDC |
| SAE 6 | 2B | | |
| 1/4 in. BSP* | 3B | | |
| 3/8 in. BSP* | | | |
| *BSP Body; U.K. Mfr. Only | | | |
| Seals | N | Coil Termination | E-Coil |
| Buna N (Std.) | V | Less Coil "E" Spacer | E |
| Fluorocarbon | | Deutsch DT04-2P | ER (IP69K) |
| | | Metri-Pack® 150 | EY (IP69K) |
| | | Dual Lead Wires | EL (IP69K) |
| | | Amp Jr. Timer | EJ (IP67) |
| | | DIN 43650 | EG (IP65) |
| | | Dual Spades | — |
| | | | DR (IP65) |
| | | | DY (IP65) |
| | | | DL (IP65) |
| | | | DG (IP65) |
| | | | DS (IP65) |

For Coils with Zener Diode, add "Z" to option code. For example: "ER/Z". Not available on all models. See coil option info. on pages 3.200.1 & 3.400.1